

Week-programme handwheel thermostat with color LCD screen

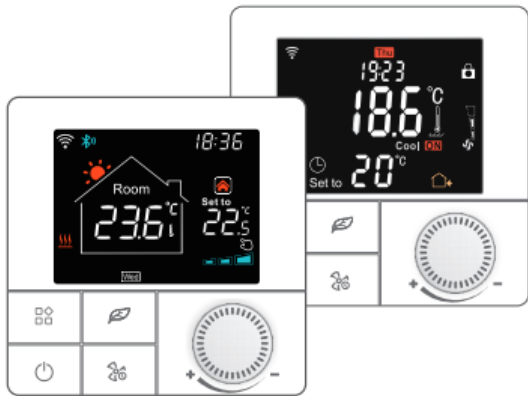

Version:TR8B 1.4(12/2021)

Product Overview

This series of thermostat has Floor Heating, Fan Coil, and Integrated version, meeting the requirements under different scenarios.

Version	System mode	Model	Application
Floor heating	Floor heating	EP	Built-in & floor sensor, floor limit sensor + Weekly programming
		WP	A NC/NO dual-output + Weekly programming
		WPB	A NC/NO dual-output + Weekly programming+ Potential-free output
Fan Coil	Heating /Cooling / Ventilation	AC2	Timer task + 2-pipe system
		AC2-485	Timer task + 2-pipe system + 485Modbus (optional) + Potential-free output + Room card (optional)
		AC4	Timer task + 4-pipe system + 485Modbus (optional) + Potential-free output + Room card (optional)
Integrated	Heating / Cooling / Ventilation/Floor heating / Floor heating + Heating	AWY	Floor heating & fan coil, weekly programming + Potential-free output + Timer task + 485Modbus (optional) + Room card (optional)

Display Symbols

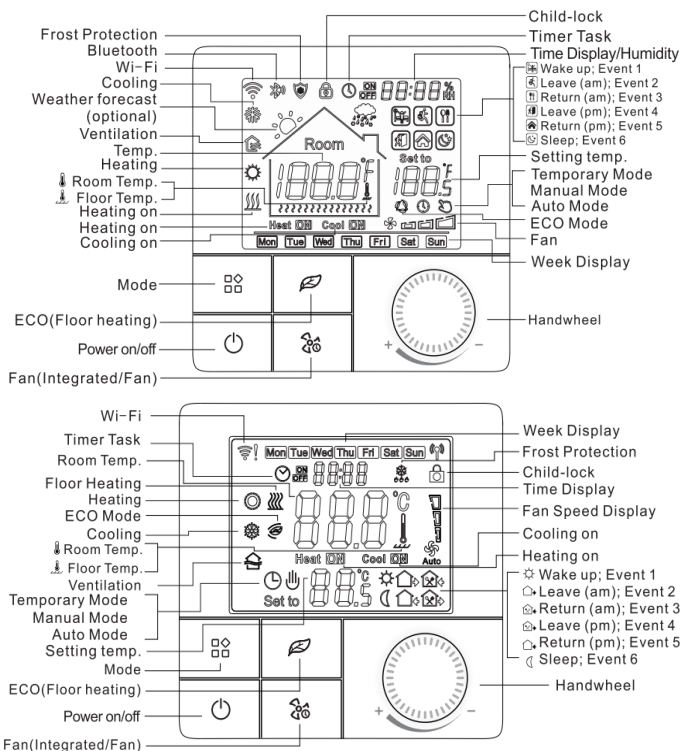

Temperature Control Mode(Floor Heating/Integrated)

Auto Mode

Weekly-circled programme, up to 6 heating events can be set per day. Heating events, workdays and temperature can be separately customized based on personal routines.

Manual Mode

Thermostat works based on manually-set temperature, disconnecting from auto mode.

Temporary Mode

Thermostat works based on manually-set temperature temporarily and then shifts back to auto mode till next event.

- ✓ Color VA screen (vertical alignment technology) - -greater sense of science and technology.
- ✓ Set temperature can be specified precisely and intuitive (by 0.5°C) via handwheel.
- ✓ Can be individually tailored to personal routines- -up to 6 heating events can be set separately.
- ✓ 485 modbus and room card linkage - customized equipment (optional)

Parameter

Supply voltage	AC100~240V; 50/60Hz
Power consumption	1W Max (Wi-Fi 3W Max)
Temp. setting range	5~95°C (41~99°F)
Floor limited range	5~47°C (41~99°F)
Temp. Dif.	0.5~10°C (1~10°F) , Factory setting ±1°C
Ambient temperature	-5~50°C (23~122°F)
Protection level	IP20
Shell material	Anti-Flammable PC

User Operation

Power on/off: Press “⏻” shortly to turn on/off the thermostat.

Auto-mode: Press “🏠” for 3 seconds to edit auto-mode settings. (Floor Heating/Integrated)

Timer task: Press “🕒” for 3 seconds to edit timer task. (Integrated)

Time setting: Press “🕒” for 3 seconds to set time. (Floor Heating)
Press “🕒” twice for 3 seconds to set time. (Automatic time synch for Wi-Fi version)

Temp setting: Rotate handwheel “🌀” to change settingtemperature by 0.5°C.

Child-lock: Press “🔒” for 3 seconds to activate child-lock.

System mode: Press “🏠” shortly to switch cooling/heating/ventilation/floor heating/floor heating + heating. (Integrated)

Temp control mode: Press “🏠” shortly to switch manual/auto mode. (Floor heating)

Press “🌀” shortly to switch manual/auto mode. (Integrated, floor heating)

Fan speed setting: Press “🌀” shortly to adjust fan speed.(Integrated)

ECO mode: Press “🌿” shortly to set to ECO mode 18°C(64°F). (Floor heating)

Advanced Setting (Usually for Professional Technicians)

Under power-off, press “🏠” for 3 seconds to enter advanced setting mode, then re-press “🏠” to switch to next mode. Press “⏻” to save and exit advanced setting mode.

Code	Meaning	Default Value	Integrated	Fan Coil	Floor Heating		
			AWY	AC2-485/AC4	AC2	EP/WP/WPB	
00	Postal address (optional)	Adjustment range 0x00~0xFA	00	✓	✓	✗	✓
01	Temp. calibration	-9.9~9.9°C (-9~9°F)	-3°C	✓	✓	✓	✓
02	Temp. Dif.	0.5~10°C (1~10°F)	±1°C	✓	✓	✓	✓
03	Temp. upper limit	5~95°C (41~99°F)	50°C	✓	✓	✓	✓
04	Temp. lower limit	5~47°C (41~99°F)	5°C	✓	✓	✓	✓
05	Frost protection	ON: frost protection on OFF: frost protection off	OFF	✓	✓	✓	✓
06	Temperature unit	°C/°F	°C	✓	✓	✓	✓
07	Sensor selection	IN: Controlled by built-in sensor OUT: Limited by floor sensor ALL: Controlled by built-in sensor and limited by floor sensor	IN	✓	✗	✗	✓
08	Floor limited temp.	20~90°C (68~99°F)	35°C	✓	✗	✗	✓
09	Weekly programming setting	12345: 5/2 week mode 123456: 6/1 week mode 1234567: 7/0 week mode	12345	✓	✗	✗	✓
10	Status of potential-free and main power outputs	00: both outputs are normally open 01: main power output is normally closed; potential-free output is normally open 02: both outputs are normally closed 03: both outputs are normally closed; under power-off, frost protection is either	00	✓	✗	✗	✓
11	Delay time of outputs	0~5min	0	✓	✗	✗	✓
12	Child-lock	00: Child-lock inactive when screen off; lock all when child-lock activate 01: Child-lock activate when screen off; lock all when child-lock activate 02: Child-lock activate when screen off; lock all except Fan Speed, Up and Down when child-lock activate 03: Child-lock activate when screen off; lock all except Power on/off when child-lock activate	00	✓	✓	✓	✓
13	Power-on-reset	00: stay power-off after Power-on-reset 01: stay power-on after Power-on-reset 02: recovery after Power-on-reset	02	✓	✓	✓	✓
14	Door card status	00: turn off room card function 01: set to ECO temp. after pulling room card out 02: stay power-off after pulling room card out	00	✓	✓	✗	✗
15	Room card heating ECO temp.	10~21°C (50~69°F)	18°C	✓	✓	✗	✗
16	Room card cooling ECO temp.	22~32°C (72~89°F)	26°C	✓	✓	✗	✗
17	Fan coil mode setting	00: Cooling and heating 01: Cooling only	00	✓	✓	✓	✗
18	Weekly programming for Integrated	00: turn on 01: turn off	01	✓	✗	✗	✗
19	Reset	Press “🌿” for 3 seconds to reset	/	✓	✓	✓	✓

Auto-mode Setting (Floor Heating/Integrated)

Press "88" for 3 seconds to edit auto-mode setting.

Events	Symbols	Time		Temperature	
		Default value	Modify	Default value	Modify
Workdays	1	☀ / ☀	06:00	20°C (68°F)	Rotate handwheel
	2	☀ / ☀	08:00	15°C (59°F)	
	3	☀ / ☀	11:30	15°C (59°F)	
	4	☀ / ☀	12:30	15°C (59°F)	
	5	☀ / ☀	17:00	22°C (72°F)	
	6	☀ / ☀	22:00	15°C (59°F)	
Weekends	1	☀ / ☀	08:00	20°C (68°F)	Rotate handwheel
	2	☀ / ☀	22:00	15°C (59°F)	

Sensor failure

Please select work mode of sensors correctly. When it shows E0/E1 error, thermostat will stay power-off till the error is eliminated. E0: built-in sensor is short-circuited or disconnected. E1: floor sensor is short-circuited or disconnected.

Timer Task Setting (Fan Coil / Integrated)

Press "88" for 3 seconds to enter timer task setting; press "88" to change settings; press Handwheel "⊙" to adjust parameters; press "⏻" to save and exit.

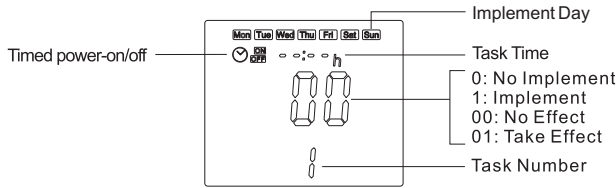

Dimensions (Unit: mm)

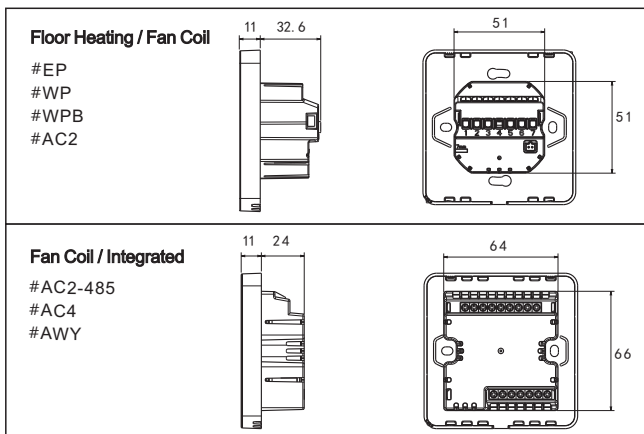

Mounting Steps

The thermostat adopt pre-guide and limited snap-fit design. It is easy to mount.

1) Release front cover by inserting a head screw-driver into bottom crack.

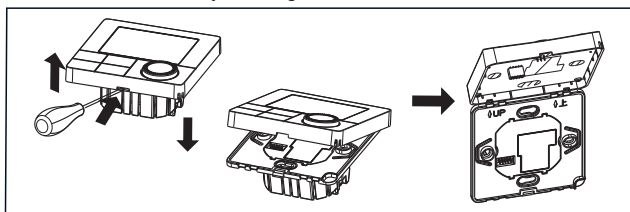

- 2) Insert the wires and then fix these wires with screws. Suggested wire-stripping length is 7-9mm.
- 3) Mount backing plate into wall-cassette, put screws and then fix thermostat. Make sure that the thermostat is fixed without deformation. Suggested torque is 0.2~0.4N.m (2.0~4. 1kgf.cm).

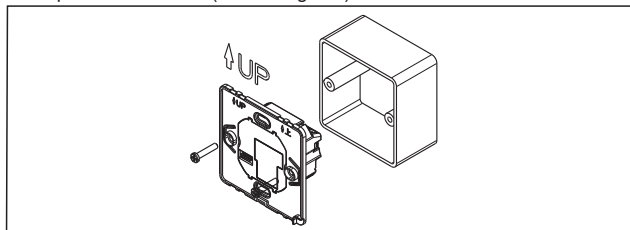

4) Re-mount the front cover via snap-fit connection.

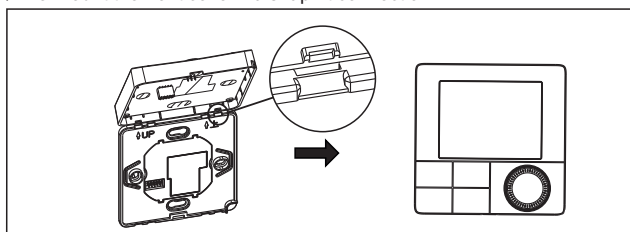

Connecting Diagram

The thermostat operates in full capacity in areas with the altitude of less than 2500 above sea level. Power rating of external load should be less than or equal to 80% rated power of the thermostat in areas with altitude of 2500m to 4200m.

